

BEAUTIFUL HOUSES FROM RICE STRAW

Taha Ashour

Agricultural Engineering Department, Faculty of Agriculture,
Benha University, Egypt.

ABSTRACT

Rice straw is one of the crop residuals that can be used as building material. Straw is the plant structure between the root crown and the grain head. The internal structure of a single straw is tubular, tough, and efficient. It contains cellulose, hemicelluloses, lignin, and silica with high bending and tensile strength. The tube shape is inherently stable and, with a microscopically waxy coat, slightly hydrophobic. Bales are compressed masses of straw left over after harvest. Straw bale construction provides high comfort and enables home owners and building managers to reduce energy consumption for heating and cooling by about 80%.

This report discusses the possibility of using barley straw as a building material. It focuses on four issues. First, it draws attention to the benefits of straw bale construction. Second, it highlights some factors influencing the use of rice straw bales as building materials such as bales preparation in the field, bale dimensions, bale type, bale moisture content, bale density and tying systems of bales. Third, the systems of straw bale buildings such as load bearing and in-fill wall system are presented. Fourth, the use of earth plaster reinforced with rice straw is discussed.

1. USE OF RICE STRAW BALE AS A CONSTRUCTION MATERIAL

1.1. Introduction

Utilizing agricultural waste requires information about the physical, mechanical and thermal properties of these materials. This knowledge helps the designer and decision maker to assess the best ways to benefit from those wastes and also to avoid the hazards resulting from burning it or leaving it to deteriorate in the field. Straw is the stalks remaining after the harvest of grain and is a renewable resource grown annually. When cereal crops are processed after harvest a number of "by-products" are created, each containing varying quantities of chaff, straw, and weed seeds, as well as some grain (Hillman 1981, 1984; Jones 1984, 1987). Straw is a sustainable low-cost material, suitable for building almost any structure, even freeway sound and safety walls. Straw is a waste product, consisting only of cereal plant stalks left after the food portion has been stripped from the plant; it is nothing but waste material, and is usually burned. Straw is virtually identical to wood in chemical composition. It is possible to use the straw of barley, wheat, rice, oats, rye, flax, grass and perhaps sugarcane waste, or even baled waste plastic, cardboard or paper.

On the other hand ancient architecture usually presents intuitive approach to building design for local climatic conditions. In the past, however, the ancient concepts have often been ignored in the design of modern buildings, which mainly use conventional fuels to provide the desired conditions. Some recent developments by integrating the ancient concepts with the knowledge of new materials have lead to a new discipline known as "Passive Buildings".

1.2. Benefits of Straw Bale Construction

A straw bale building is easy to modify, flexible enough to be used in a variety of ways, solid and substantial, durable over time, and easy to maintain. In addition, it requires only simple tools and unspecialized labour, which can be easily acquired and affordable in most locations around the world. Straw bale constructions have different benefits such as aesthetics and comfort, ease of construction, energy efficiency, environmental benefits, sustainability and seismic resistance.

1.2.1. Beauty and Comfort

The bulk and subtle surface of straw bale walls have special character and beauty. These walls create an overall feeling of comfort not found in the thin flat walls often produced from modern materials. When finished with natural plasters and paints, straw bale walls can breathe resulting in fresh, invigorating, and clean indoor atmosphere compared to the low-oxygen, stale, toxic air common to most homes. The high insulation value of bales also helps create a very stable environment easy to cool and heat. It provides far superior living conditions to most modern housing.

1.2.2. Ease of Construction

Building walls from straw is much less labor intensive than using other materials such as concrete blocks, brick, adobe, or stone, and requires considerably less skill. Bale building encourages individual creativity and leads to final structures that are climatically adapted and energy efficient. Many people would have a great deal of fear and anxiety about building a home with conventional materials. The complexity, skill required, time involved, and cost can be prohibitive and daunting. Building with straw bales relaxes the whole construction process and allows inexperienced and unskilled people the opportunity to become directly involved in creating their own homes. One of the great beauties of this system is that everyone can participate in building a home, including women, children, and others who have been disenfranchised from the building process. This coming together of people to help each other often generates a great deal of excitement.

1.2.3. Energy Efficiency

Straw bale buildings are thermally efficient and energy conserving, with R-values significantly better than conventional construction, depending on the type of straw and wall thickness. Straw bale walls can provide improved comfort and energy savings compared to more expensive conventional building systems. Straw bale buildings allow smaller heating or cooling systems to be installed than in conventional homes. To get the most benefit from the highly efficient walls of a bale building, the building should include a well-insulated attic or roof, where straw can be used in many cases. Moreover, the following measures are usually needed: good perimeter foundation insulation, insulated windows and doors, proper sealing to minimize drafts, and optimal ventilation achieved either by plastering and coloring the walls

with a breathable finish or by using an air-to-air heat exchange to efficiently bring in fresh air. The high insulation and mass of bale walls will make it possible to keep the windows open much of the year, providing cleaner air inside. The excellent insulation value of straw bales also makes passive cooling systems, such as the cool pool or down draft cooling towers, more practical and efficient for homeowners in very hot arid areas.

1.2.4. Environmental Benefits

Straw bale construction can provide benefits in regions where straw has become an unwanted waste product. The slow rate of straw deterioration creates disposal problems for farmers because unlike nitrogen-rich hay, straw cannot be used for animal fodder. The farmers need to get rid of straw by burning it, causing black smoke and severe pollution in the atmosphere. Barley, wheat and rice straw produce a lot of carbon monoxide when they are burned.

1.2.5. Sustainability

The conversion of straw into a sustainable renewable resource to be used as building material could be especially beneficial in areas like the steppes of Russia and the Plains of Northern China, where the climate is severe and timber is scarce, but straw is plentiful. Straw bale construction would also be ideal for many desert areas where barley, wheat and rice are grown along riparian belts and river valleys. Using soils to make good adobe or earth blocks, as is happening in Egypt where agricultural land is at a premium, is clearly not a sustainable practice. Desert areas are also traditionally timber poor. The prospect of sustainability for any given product or system is that the energy required to manufacture or operate it is kept to a minimum. When straw is evaluated for sustainability as a building material, it rates very high. It bypasses much of the energy and waste needed to produce industrial building materials.

1.2.6. Seismic Resistance

Straw bale buildings will be of special value in areas where earthquakes are common, as straw bales have a good width to height ratio and can be easily and effectively reinforced. The bale walls may actually absorb much of the shock of an earthquake, and the plaster adds to the strength of these buildings. The material properties of straw bales; their flexibility and strength, make them ideal for seismic-resistant structural design. The integrity of straw bale

buildings is available as long as the connections between the bale wall system and the roof and foundation are adequate.

1.3. Fire Safety

Building materials are classified into four different groups: (not inflammable, A, hardly inflammable, B₁, normally inflammable, B₂, easily inflammable, B₃). The straw bales are classified as B₂, benefited from the lack of oxygen in the compressed straw bales, which results in a high fire resistance. The National Research Council of Canada 1980 carried out fire safety tests of plastered straw bales and found them to be more resistant to fire than most conventional building materials. The mortar-encased bales passed the small-scale fire test with a maximum temperature rise of only 43°C over four hours. The plaster surface coating withstood temperatures of up to 1010°C for two hours before a small crack developed.

In 1993, fire tests completed in the state of New Mexico showed equally positive results. Two tests were conducted, one on an unplastered straw bale wall panel and the second on a straw bale wall that had been plastered on the heated side and stuccoed on the outside face. The fire test conducted on the unplastered wall section met the standard requirements of exposing the interior face of the panel. The temperature rose to 537.7°C within five minutes and to 843.3°C after thirty minutes. The temperature rise on the unheated side of the panel was about 1.1°C. It took thirty-four minutes for the fire to burn through the center of the test wall, not through the middle of a bale, but at a joint where bales met. When the panel burned through at the joint, the rest of the bales were only charred halfway through, about 22.9 cm of the 45.7 cm thickness of the two-string bales tested (Steen et al., 1994). The plaster of straw-bale wall is an excellent fire barrier, possibly deserving as much as a three or four-hour fire rating. This is due to the fact that the bales contain very little oxygen and are too dense to sustain fire (King, 1996).

On the other hand, loose straw is highly flammable, and appears in abundance onsite when bales are cut, shaped, fitted, and set in place. Therefore fire is of great concern to the straw-bale builder and of surprisingly little concern to the owner of the finished building. The plaster coating effectively seals the already fire-resistant bales inside a non-combustible casement. Fire would have to burn through the plaster in order to reach the straw. When plaster is combined with a massive bale wall, fire resistance is enhanced (Magwood and Mack, 2000).

1.4. Straw Bale Properties for Buildings

Straw is defined as the stems or stalks of certain cereals, chiefly wheat, rice, barley, oats and rye. Their physical, mechanical, thermal and chemical properties are of importance for straw bale buildings.

1.4.1. Bales Preparation and Tying Systems

At first, the straw is raked from the field and fed into mechanical balers. The bales are a rectangular compressed blocks of straw, bound by strings or wires. The bales shall be mechanically bound with baling wire or poly-propylene string. Bales shall be bound with at least two strings running parallel to the longest edge. The bales with broken or loose ties shall not be used unless the broken or loose ties are replaced with ties which restore the original degree of compaction of the bale. The straw distribution inside the bales is not homogeneous, i.e., they have some grain or orientation and different qualities in different directions based on how the baler works. Fig. 1 illustrates the bales preparation in the field. The baler picks up straw stems from the ground surface and compresses the straw into bales.



Figure 1. Bale machine in the field (Ashour, 2003)

The narrow end-faces receive the compression of the baler head, which thrusts straw masses in ‘pulses’ into the chamber. These pulses compress the straw into flakes of about four inches thickness. Thus, a typical bale consists of a series of four-inch flakes compressed along the bale’s long axis. The baler operates continuously with a series of slightly varying pulses of straw mass and the straw is cut and tied off at the end of a flake. There are two types of straw bale tying systems. The first system is two string bale type. The two string tying system is widely used. It is easy to handle and has a weight ranging from 15 to 19 kg (Fig. 2).

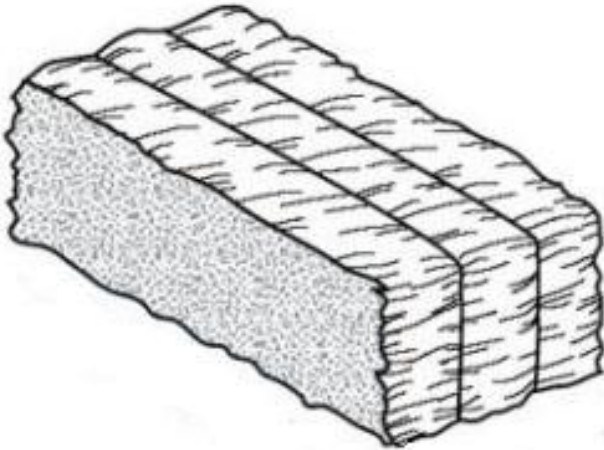

Figure 2. A two string bale

The second system is the three string bale type to produce heavier bales. The average weight of this straw bale is about 29 kg (Fig. 3).

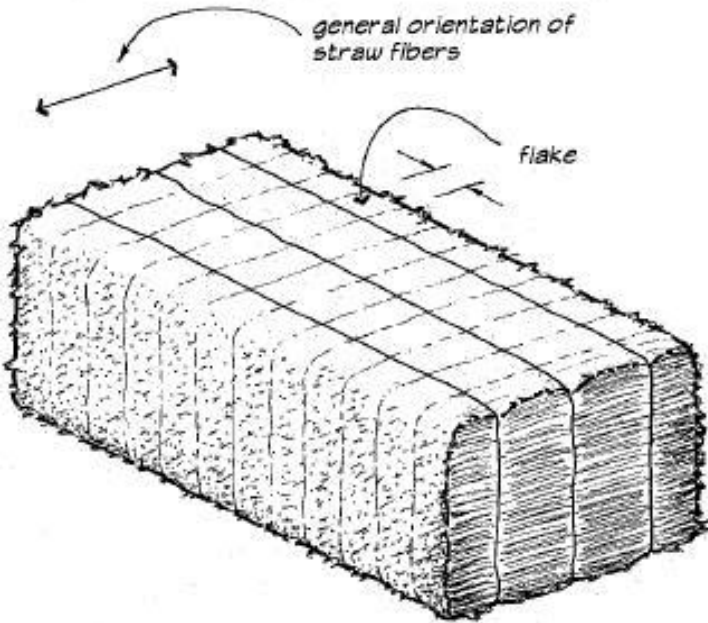

Figure 3. A three string straw bale and flake

Bales lying on their largest face can carry more load than bales on any other edge. The simple geometry makes the flat bale much stronger and stiffer. The orientation of the straw fibers, which is predominantly horizontal, also makes the bale more stable. The flat bales are also better for plastering, as the exposed cut straw ends are ideal for receiving and bonding the plaster.

1.5. Physical Properties of Bales

The physical properties of the straw bales are very important for bale strength to loads and heat and mass transfer through the straw bale construction. These properties are bale dimension, surface area, volume, density, moisture content and equilibrium moisture content.

1.5.1. Length of Straw Particles Inside Bales

The straw distribution inside the bale is very important for the properties of bales. The straw length mostly ranges from 2-50 cm. For barley straw bale, about 95% of straw bale fibres are less than 1-2 cm, with 5% of its components having length of 2-50 cm. While about 76 % of wheat straw fibers are shorter than 1-2 cm and 24% with length of 2-50 cm. The results show that barley straw bales contain much finer straw particles compared to the wheat straw bales. This indicates that the barley straw bales with the same dimensions have higher weight than that of the wheat straw bales (Ashour, 2003).

1.5.2. Bale Dimensions

Straw bale dimensions depend on the baler channel. The medium sized rectangular three-string bales are preferred for building construction. Three-string bales are better structured and are often more densely compact (Wimmer et al., 2001). A typical medium-sized, three-wire bale may be 58 X 40 X 106 cm (Fig. 4).



Figure 4. Three string straw bale

The smaller two-wire bales, which are easier to handle, are 45 X 35 X 91cm (McCabe, 1993) (Fig. 5).



Figure 5. Two string straw bale

1.5.3. Bale Density

Bale density varies widely depending on the type of grain, moisture level, and the degree of compression provided by the baler. The bale density ranges from 54.6-78.3 kg/m³ for barley straw bales and 81-106.3 kg/m³ for both oat and wheat straw bales (Watts et al., 1995).

While Lerner and Goode (2000) mentioned that the dry density for straw bale building is about 112 kg/m^3 . McCabe (1993) found out that the optimal density for wheat and barley straw is about 133 kg/m^3 , while the optimal density for rice straw is about 123.6 kg/m^3 .

1.5.4. Moisture Content

Moisture content depends on the circumstances at the time of baling and during subsequent storage and transport. The safe moisture content is about 15%, which corresponds to a certain water activity level or equilibrium relative humidity (Bainbridge, 1986). While King (1996) mentioned that few organisms are able to decompose straw, which is why grain straw is so often burned rather than composted. However moisture level in straw bales over 70% can provide a habitat for fungi and lead to decomposition, therefore careful design for moisture avoidance is critical.

On the other hand, the behaviour of moisture within buildings is complex and dependant upon several variables such as seasonal climate, site conditions, building usage, heating and cooling systems and wall construction. Moisture trapped within the building envelope (walls floor and roofs) can cause degradation of wood or straw, and reduce the efficiency of insulation materials (Swearingen, 2001).

The composition of wood and straw are quite similar, while both consist largely of cellulose and inorganic materials. Barley straw is more resistant to moisture however and it is very fibrous and does not decompose easily. Its total moisture content must exceed 20% before decomposing fungi will be able to grow (Chapman, 1996).

1.5.5. Thermal Insulation of Straw Bales

The term thermal insulation refers to materials used to reduce the rate of heat transfer, or the methods and processes used to reduce heat transfer. Heat energy can be transferred by conduction. In heat transfer, conduction is the transfer of thermal energy between neighboring molecules in a substance due to a temperature gradient. It always takes place from a region of higher temperature to a region of lower temperature, and acts to equalize the temperature differences.

Straw can be any mixture of barley, wheat, rye, rice and oats. These natural ingredients are packed into bales which provide excellent thermal insulation for buildings. Although walls can be built with straw bales alone, straw is often used as insulation, and wooden beams are used for load bearing purpose.

Additionally, thermal insulation prevents heat from escaping or entering a container. Thermal insulation can keep an enclosed area such as building warm, or it can keep the inside of a container cold. The insulation value depends mainly on weather condition. Stone (1999) estimated the insulation value for the straw bale walls. The thermal conductivity for the bale walls is 0.04 W/mK. Also, the 'U' (thermal transmission) value is 0.13W/m²k for a 450 mm wide bale. Ashour (2003) investigated the thermal conductivity of barley straw bales. Fig. 6 shows the average thermal conductivity and thermal resistance of barley straw bales at three different temperatures 9.6, 20.6 and 32.2 °C within density range of 68-98 kg/m³. The thermal conductivity tests were conducted on samples of size 60 X 38 X 36 cm for length, width and height respectively.

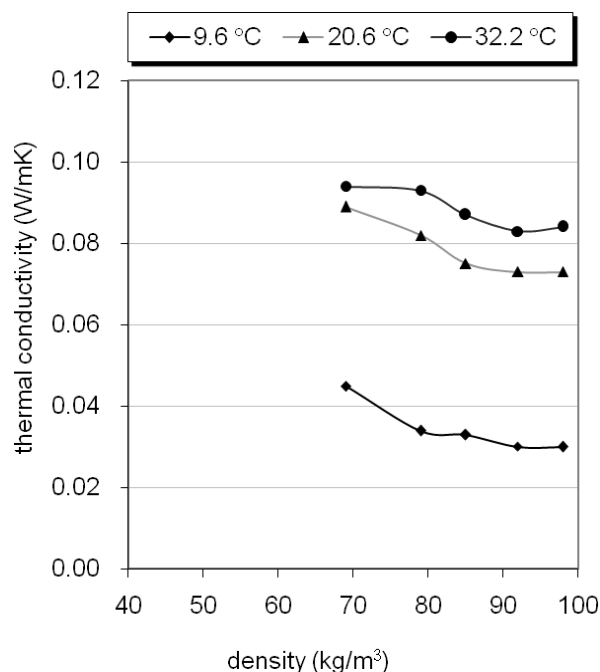

Figure 6. Thermal conductivity for barley straw bales as affected by density and temperature.

The results indicate that thermal conductivity increases with increasing temperature. It can also be seen that the thermal conductivity decreases with increasing bale density. The minimum thermal conductivity 0.03 W/mK was recorded at the bale density of 92-98 kg/m³ at 9.6 °C temperature. The maximum thermal conductivity value (0.094 W/mK) was recorded for the lowest density (69 kg/m³) at 32.2 °C temperature.

Multiple regression analysis was carried out on the thermal conductivity data as a function of bale density and temperature. The following relationship was obtained:

$$k = 0.0603 - 0.0005 \rho + 0.0022 T \quad (R^2 = 0.87) \quad (1)$$

where k is the thermal conductivity, W/mK; ρ is the bale density, kg/m³ and T is the temperature, in °C.

1.6. Straw Bale Walls Types

There are two systems for straw bale building constructions, namely load bearing walls and in-fill walls systems as follows.

1.6.1. Load-Bearing Bale Walls

The large size of straw bales makes most bale walls inherently stable. While barley straw bales are compressed into rectangular blocks and bound by strings or wire, the flakes are slabs of straw removed from an untied bale. The flakes are used to fill small gaps between the ends of stacked bales. As a consequence, the sides with the largest cross-sectional area are horizontal and the longest side of this area is parallel to the wall.

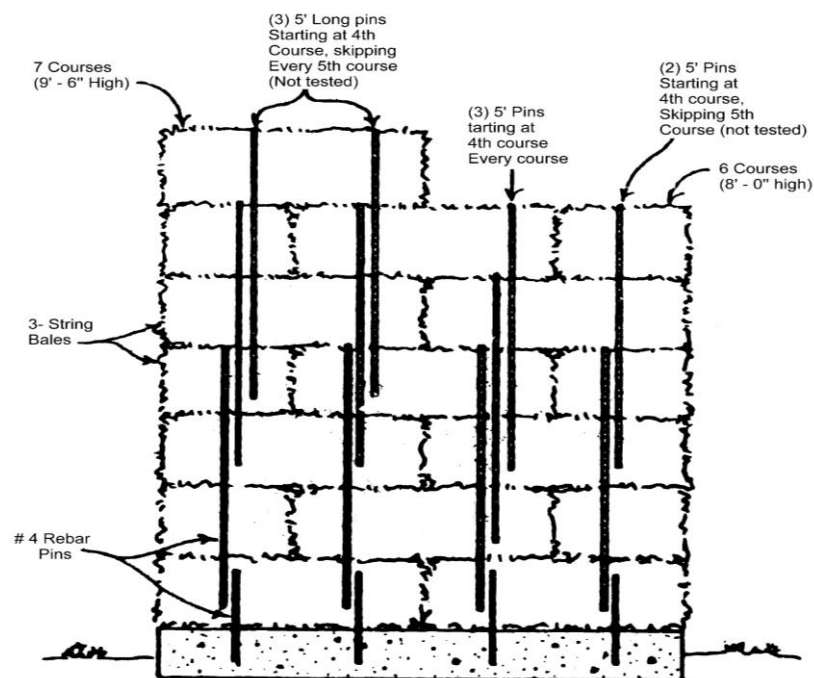

Figure 7. Pinning bales to form load-bearing wall

In load-bearing walls, each bale sits over the vertical joint between the two bales beneath it. The bales are pinned together with any material that suitably reinforces the wall (Fig. 7). When the envisaged height is reached, a horizontal structural member or assembly (a roof

plate) is laid on top of the bale walls. The roof plate stabilizes the walls to bear and distribute the weight of the roof; and to provide the means of connecting the roof to the foundations. Usually the walls will settle under the weight of the roof shortly after roof placement (Fig. 8). Once the compression process is completed, the walls are plastered.

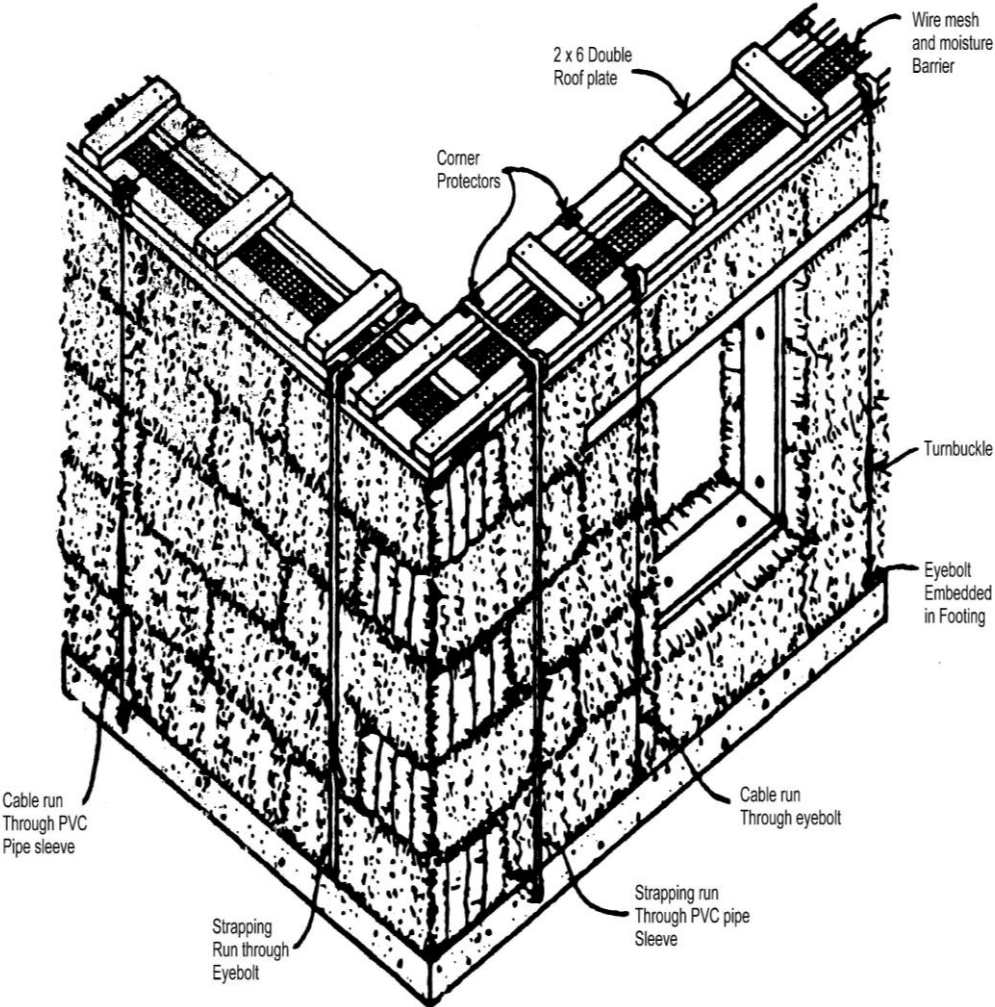

Figure 8. Load bearing wall

Alternatively, the bales are compressed after being laid in the walls. The roof loads are distributed equally through straw bale wall. The compression can be done by in different ways. A common method uses polyethylene packing straps to compress the bales as shown in Fig. 9. When constructing load bearing walls, extra care must be taken to insure that the bales do not get wet, since the consequences of rotting and decay can be severe.

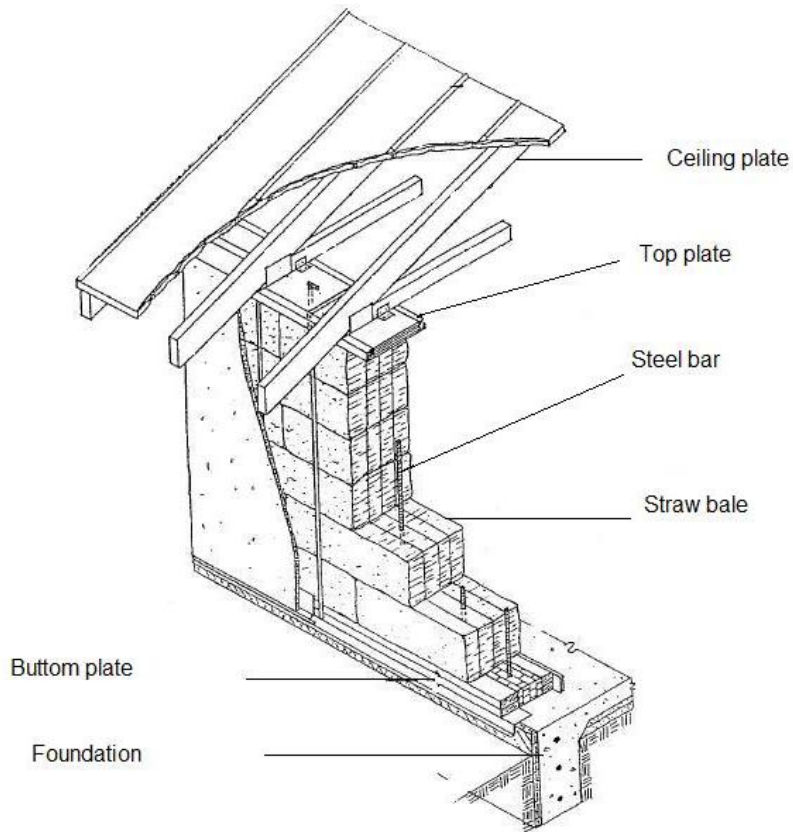

Figure 9. Load bearing wall cross section

There are different designs for load bearing structures such as walls with post compression, with skin as structure and with integrated compression such as (a) post compression system, (b) wall with skin as structure system and (c) integrated compression system as illustrated in Fig. 10.

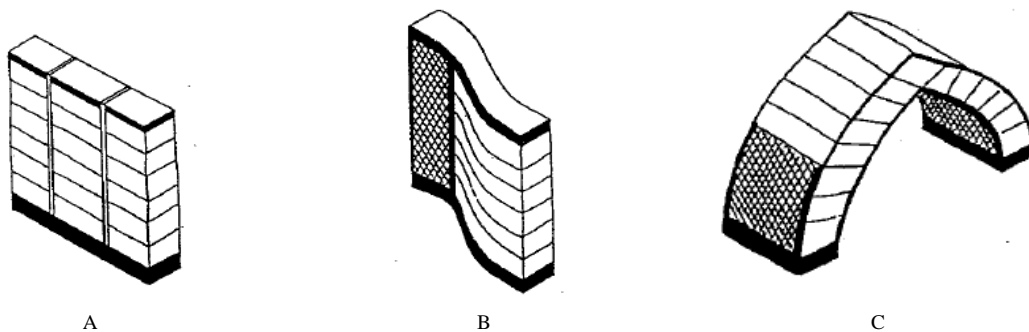

Figure 10. Load bearing structures, a) post compression system, b) wall with skin as structure system and c) integrated compression system

Furthermore, it is essential to understand that once plaster is applied directly to either or both bale surfaces, with or without reinforcing mesh, the structure is a hybrid of straw and

plaster. Effectively, any further loading such as snow, people, wind, and earthquakes will be partly sustained by the plaster skin. The share of load between straw and plaster depends mainly on the stiffness of these two materials.

1.6.1.1. Construction and General Requirements

For safety reasons some general requirements on straw bale construction shall be observed including wall thickness, wall height, allowable loads etc.

(a) Wall Thickness

The structural stability of straw bale walls depends mainly on the wall thickness. The massive bale dimensions are beneficial to the wall stability. The nominal bale wall thickness shall not be less than 36 cm.

(b) Wall Height

The straw bale walls should not exceed one story and the bale slenderness shall not exceed the height to width ratio of 5.6:1. The height of bale wall with the thickness of about 58.4 cm shall not exceed 3.3 m. Exceptions are allowed provided the wall is designed by a professional engineer or architect and approved by the building official.

(c) Allowable Loads

The allowable vertical load (live and dead load) on the top of the load-bearing walls shall not exceed 1757 kg/m² and the resultant load shall act at the centre of the wall.

(d) Foundations

When designing a bale structure, whether load-bearing or not, the type of foundation is usually the first decisions to be made. There are two commonly used foundation types, namely slab on grade and raised floor. Sometimes these foundations are slightly modified to reduce the amount of concrete used (Fig. 11). The specifications of the foundation should be determined by a licensed professional, e.g. a geotechnical engineer.

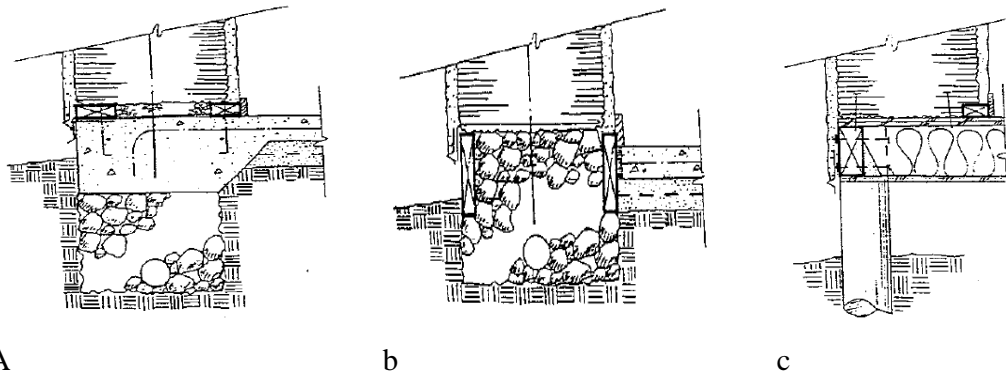

Figure 11. Types of foundation, (a) Rubble Trench, (b) Framed Box and (c) Raised floor

1.6.2. In-Fill Wall System

Straw bales can also be used as wall insulation due to their superior insulation quality. The bales should have a protected, well ventilated air space above the bales to prevent moisture accumulation. Straw bales can be used as insulation in built-up floors for climates where radiant insulation would not be sufficient (Fig. 12). The bales shall have a minimum of two strings running parallel to the longest edge and shall be dense enough to be handled without falling apart to resist settling. If a partial bale is required, it should be split from a full bale and retied to maintain the bale density. All bales shall be tested on site for compression before being placed in position. The bales shall be well compressed to remain intact when lifted by one baling wire or polypropylene twine (Lerner and Goode 2000).

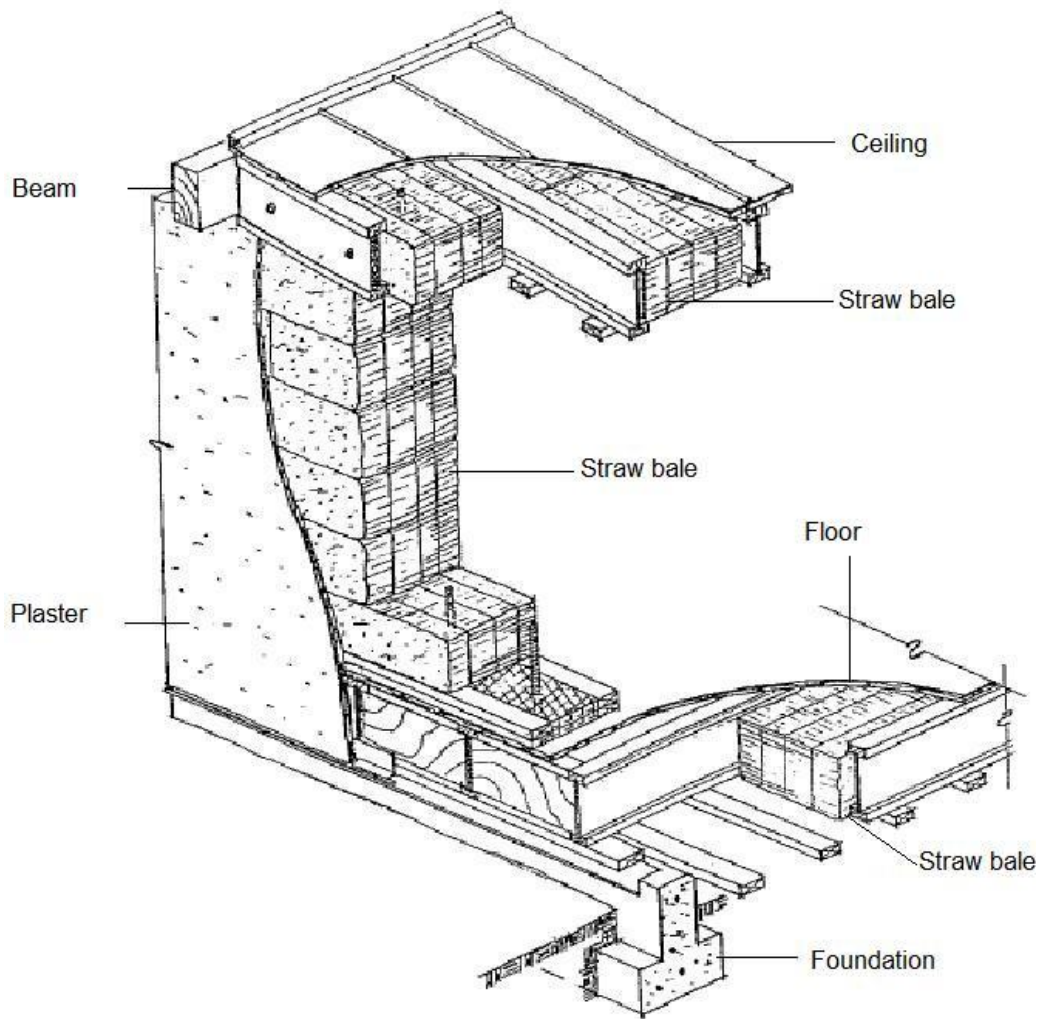

Figure 12. Cross section for in-fill wall system

Furthermore, the straw bales shall be placed within the structural members so as not to carry any weight other than the weight of the bales themselves (Fig. 13).

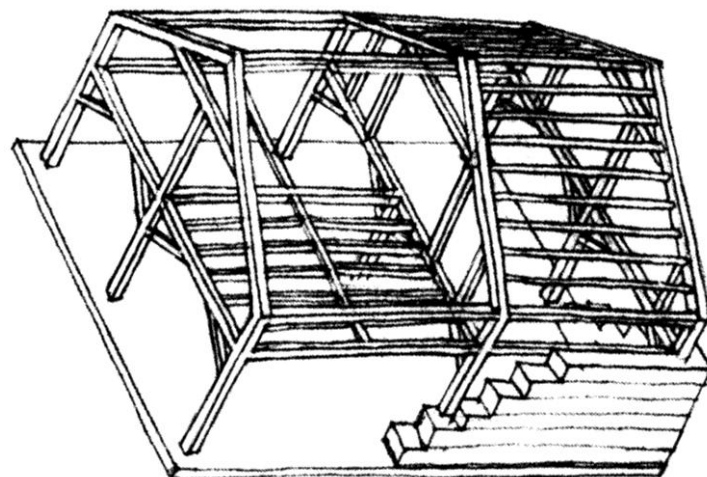

Figure 13. Structure of an in-fill wall system

In other system application, the structural supports are held to the outside of the wall. For vertical supports, many materials can be used although poles are often used (Fig. 14). Treated poles like telephone poles can be used without health concerns since they are placed outside the wall and can be stuccoed over.

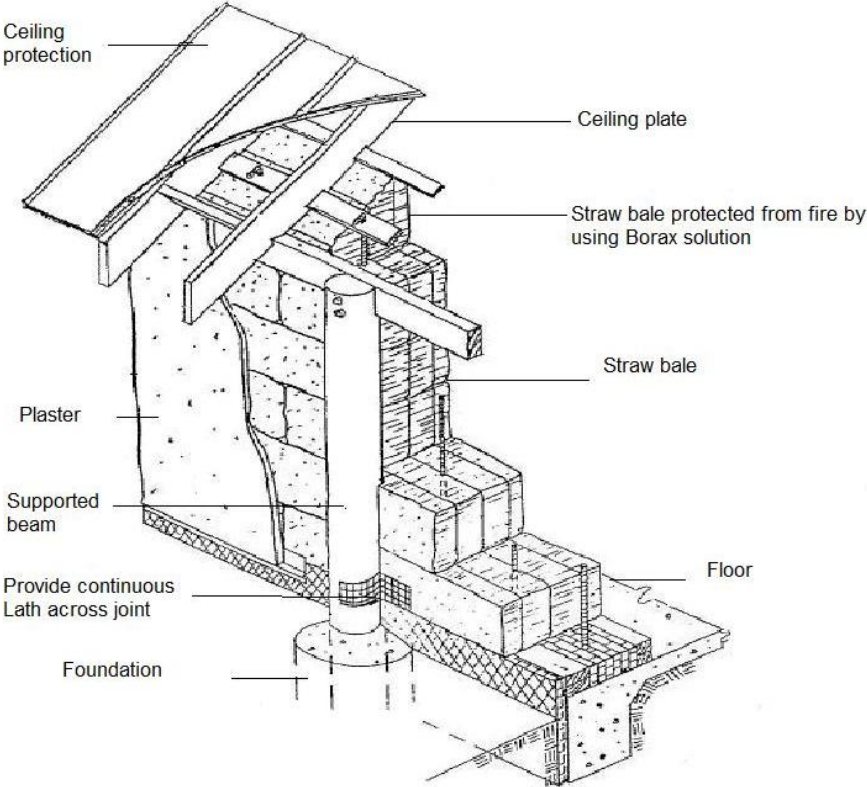

Figure 14. In-fill straw bale wall section with supports outside the wall

There are different structure designs under this type of building such as (a) in-wall medium frame system, (b) interior independent frame system, (c) exterior frame system and (d) ceiling and floor in fill system as illustrated in Fig. 15.

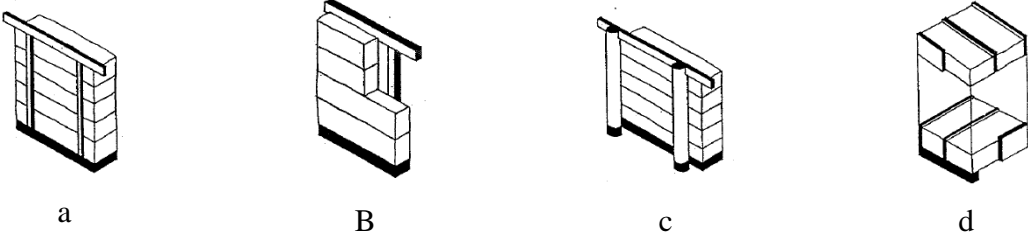

Figure 15. Possible in-fill wall designs

1.6.2.1. Wall Construction

The ratio of unsupported wall length to thickness shall not exceed 13:1. For a 58.4 cm thick wall the maximum unsupported length is about 7.6 m. The structure is to be designed by a professional and approved by a building official. The foundation shall be constructed in such a way that the bottom of the lowest course of straw bales is at least 15 cm above the final exterior grade. The straw bales used for in-fill walls should be laid flat with the vertical joints staggered at each course with a minimum overlap of about 30.5 cm (Lerner and Goode, 2000).

1.6.2.2. Vapor Barriers

The major concern for all straw bale buildings is the potential damage from water. Water can enter a bale building in different forms, e.g. by absorption through the stucco and wicking up from the foundation in its liquid form, by condensation on cold surfaces as water vapour in its gaseous form and by leaks through any part of the skin of the building (Fig. 16).

To achieve good protection from water and moisture, the elements shown above should be detailed into the building. The careful consideration of these aspects should allow the moisture content in straw to remain below 14% in order to avoid any potential moisture damage.

Furthermore, a moisture barrier shall be provided between the foundation and the first course of straw bales. The barrier shall run vertically between the perimeter insulation and the foundation wall and shall run horizontally under the straw bale and then double back to the outside edge of the foundation. A vapour barrier shall be placed over the top course of bales to prevent moisture entering the top of the bale wall.

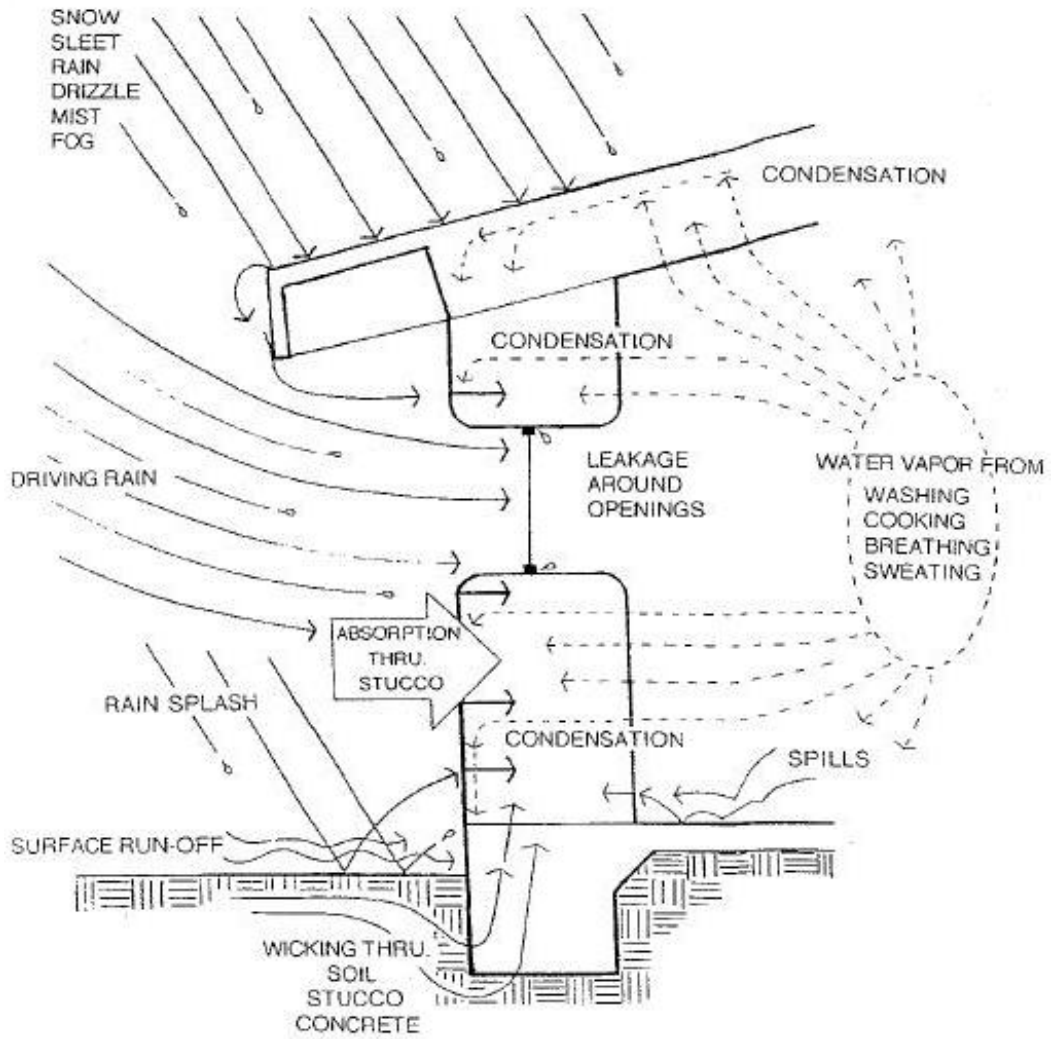

Figure 16. Water vapour condition for straw bale buildings

1.6.2.3. Anchors

The straw bale in-fill walls shall be securely anchored to the adjacent structural members to sufficiently resist horizontal displacement of the wall. Usually metal laths are used for this purpose, which are attached to the upright posts and then to the bales using flat head spiral nails (Fig. 15).

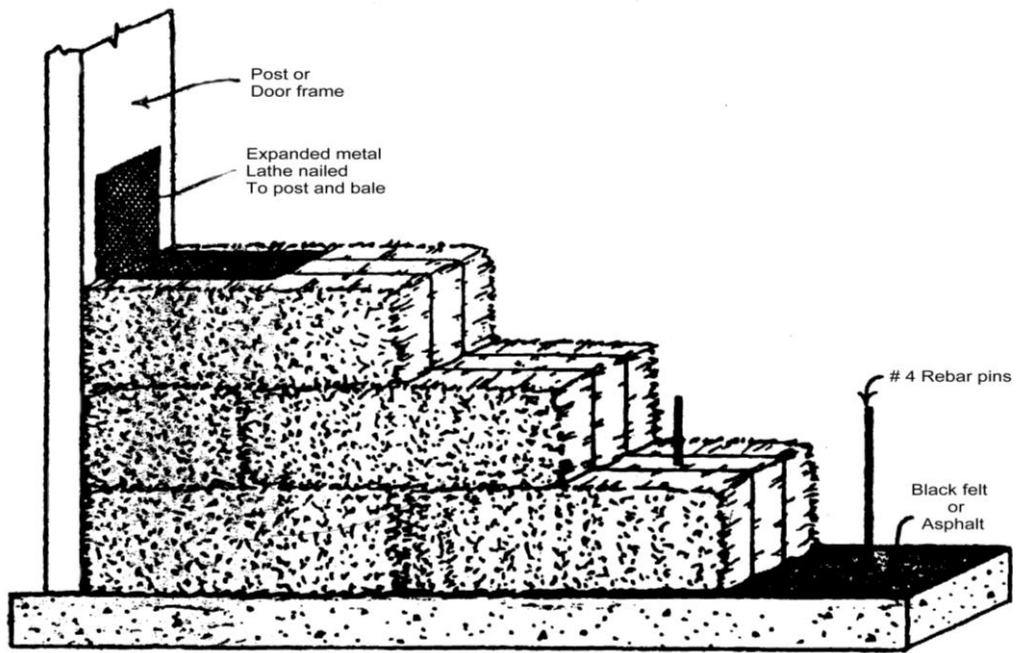

Figure 17. Straw bales fixing by metal lath

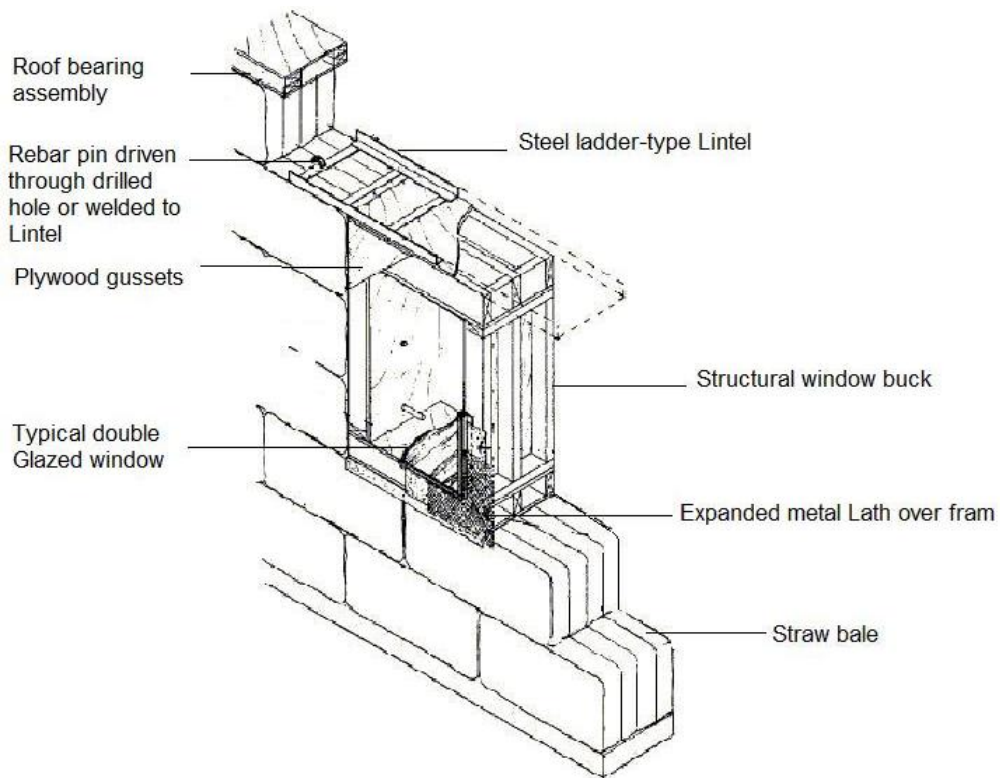

Figure 18. Openings design for straw bale buildings

1.6.2.4. Openings

There are several factors to be considered when designing and detailing window and door openings within a straw bale wall. The most obvious factor is the stability of the overall

structural system. Window or door openings within a load bearing straw bale wall attract both roof and wall loads. The openings must be treated as structural elements (Fig. 18). Obviously only loads above the opening need be considered. The opening is created with the help of a framed rough opening called a buck. The purpose of a buck is to reserve the space within the bale wall and act as a rigid frame to mount and support the window or door frame. The bucks are either secured in place before stacking or secured as bales are being stacked. To maintain the structural integrity full bales should be used around openings when possible.

1.6.2.5. Electrical Installation

The placement of utilities and other secondary elements such as cabinets, light soffits and trim are relatively easy in straw bale construction if one plans ahead and is aware of some simple techniques as illustrated in Fig.19 and Fig. 20.

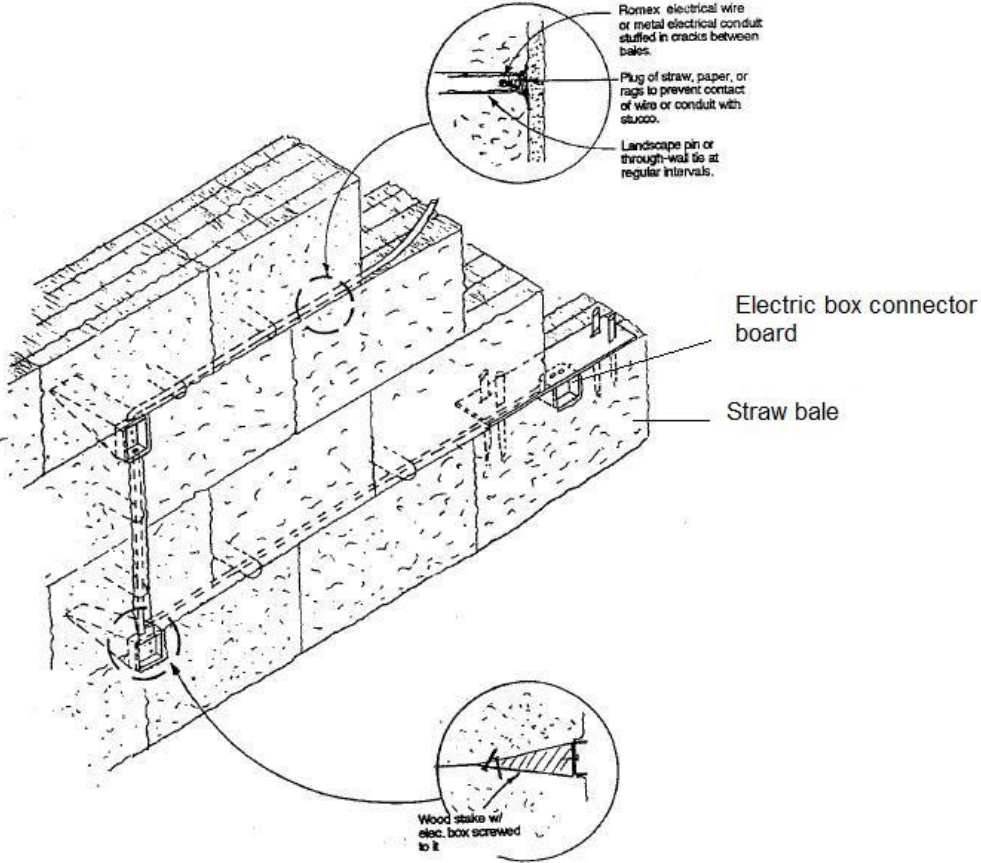

Figure 19. Electrical system for straw bale buildings

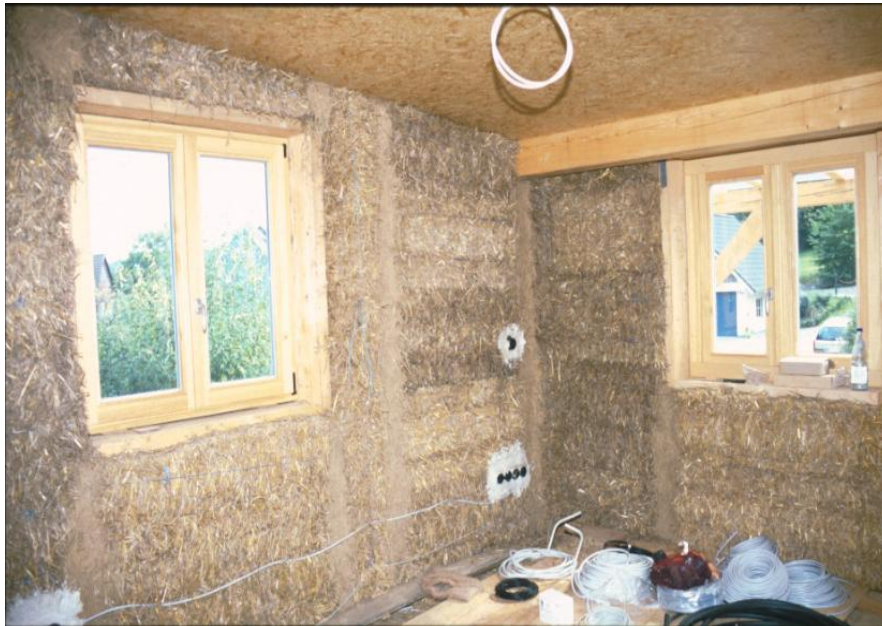

Figure 20. Electrical system of straw bale buildings without plastering

All wiring within bales may be pressed between vertical and horizontal joints of the bales, or bales may be channelled, maintaining a minimum depth of 3.2 cm from the surface of the interior wall finish. All junction boxes shall be fastened securely. The methods and materials shall be confirmed to existing national and state codes.

1.6.2.6. Plumbing

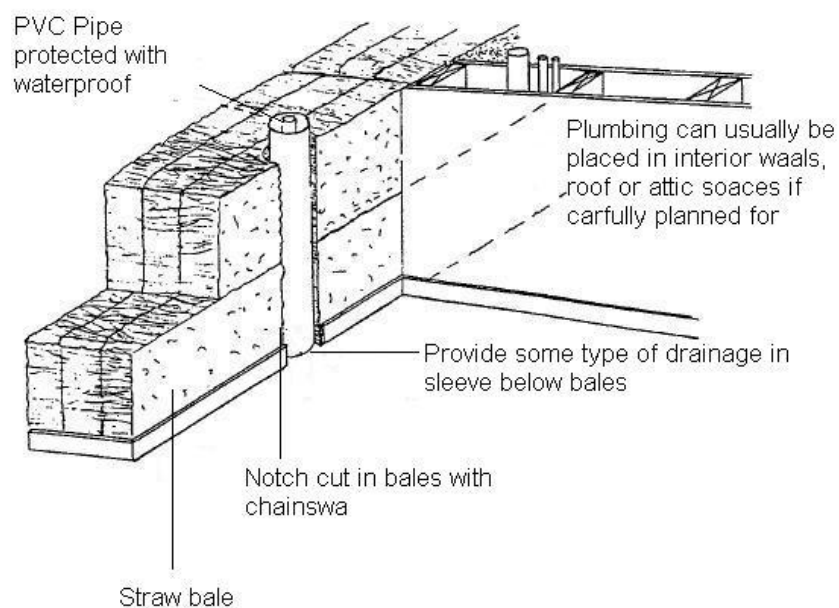

Figure 21. Plumbing design for straw bale constructions

Plumbing shall be best kept out of straw bale walls due to potential leaks or condensation on colder surfaces of pipes. Plumbing can usually be placed in interior walls, roof, or attic spaces if carefully planned (Fig. 21). In bath room, tiles can also be used on the wall and floor to protect them from water and condensation (Fig. 22).



Figure 22. Tile finishing of the bathroom in a straw bale house (Spreitzer 2010)



Figure 23. Straw bale house with solar collector (Spreitzer 2010)

A straw bale house after finishing is aesthetic and offers high comfort. Solar energy can be integrated to further reduce the energy consumption (Fig. 23).

Inside the straw bale house, furniture from natural materials is often preferred to stick to the philosophy of “back to nature” (Fig. 24 and Fig 25).



Figure 24. Living room of a straw bale building with wood furniture (Spreitzer 2010)



Figure 25. Straw bale house interior (Spreitzer 2010)

2. BARLEY STRAW AS REINFORCEMENT FIBRES FOR EARTH PLASTER

The use of natural earth plasters is experiencing a renaissance in sustainable building practice. In recent years the traditional practice of plastered straw bale structures increases considerably due to its economic and environmental benefits (Fig. 26).



Figure 26. Earth plaster reinforced with barley straw



Figure 27 .Earth plaster of straw bale building

Earth plasters for straw bale buildings may serve multiple purposes, e.g. protection of the underlying surface, enhancement or prevention of moisture migration and load carrying. Earthen plasters incorporating chopped straw are commonly used in straw bale wall construction because the straw provides tensile strength and is readily available. The straw fibre in earth plaster has similar function as the fibres in fibre reinforced composites, which are widely used as modern material in various fields from civil engineering to aerospace engineering (Brownie et al. 1993, Shi and Zhou 2000, Thomason and Dwight 2000, Baklanova et al. 2006, Fu et al. 2006).

The straw fibre helps to increase the strength, to control shrinkage cracks and to improve toughness (Lerner and Donahue 2003) (Fig. 27). Reinforcement of earth plaster by using barley straw fibres has several advantages e.g. improving the thermal insulation of earth plaster, decreasing the erosion of earth plaster and improving the shrinkage properties of earth plaster.

The behavior of plasters has been investigated among others by Ashour et al. (2010), where the thermal conductivity of earth plaster reinforced with barley straw fibres was investigated. The average thermal conductivity of dry basis at 10°C ($\lambda_{10\text{dry}}$) was about 0.12856, 0.201 and 0.248 W/mK for fibre percentages 75, 50 and 25% respectively. While thermal conductivity at dry basis (λ_{dry}) of plaster reinforced by barley straw fibre was 0.154, 0.241 and 0.297 W/mK for fibre percentages 75, 50 and 25% respectively, as shown in Fig. 28.

The results of thermal conductivity at dry basis (λ_{dry}) showed also that increasing the fiber content of barley straw to 75% leads to increasing thermal insulation to 44.4%. Since both the fibre content and the sand content were changed simultaneously, it is difficult to separate the influence of each of them.

It is clear that the thermal conductivity of the plaster material reinforced with barley straw fiber decrease with increasing fibers content, but it increased with increasing the sand content.

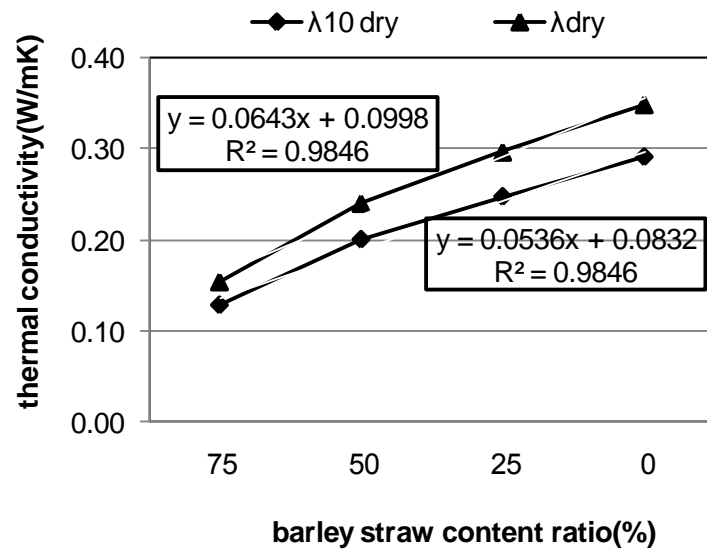

Figure 28. Thermal conductivity for earth plaster reinforced with barley straw

Furthermore, Ashour and Wu (2010) studied the effect of barley straw fibres on erosion resistance for earth plaster. Fig. 29 shows the erosion rate of plaster material reinforced with barley straw fibres. The average of erosion rates were 0.10, 0.47, 0.53 and 12 cm/hr for reinforcement fibres percentages 75, 50, 25 and 0 % respectively.

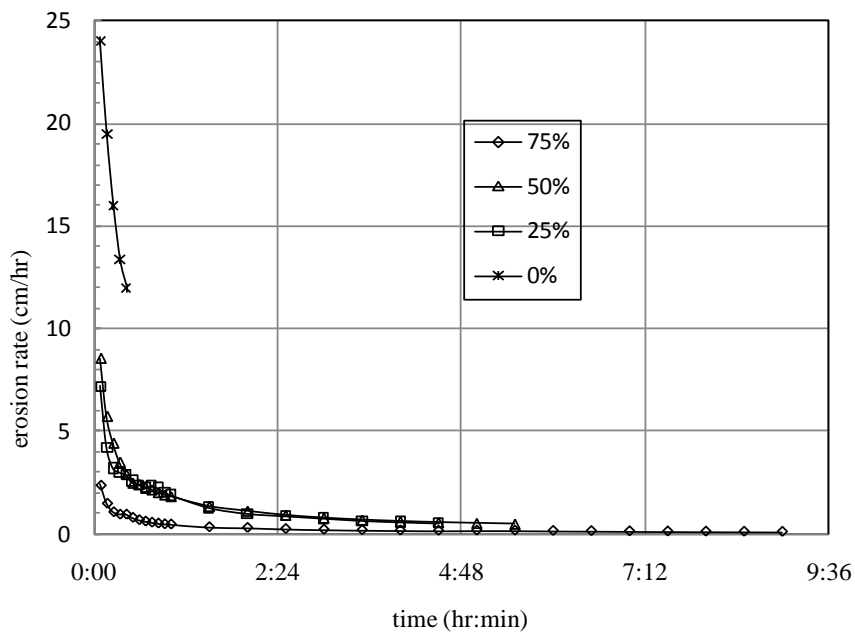

Figure 29. Erosion rate of plaster reinforced by wheat straw fiber

The results indicate that, increasing barley straw fibres from 0 to 75 % caused a decrease in erosion rate from 12 to 0.11 cm/hr for plaster reinforced by barley straw fibres. At the start

the test erosion rate was very high and afterwards the erosion rate decreases. This is due to the fact that the reinforcement fibres at the sample surface are lower than that in the interior. The subsurface layer has high fibre content and is therefore more resistant to erosion.

The average amount of water leading to complete failure of the block was 34.02, 20.79, 17.61 and 1.58 liter for fibre percentages of 75, 50, 25 and 0% respectively. This means that increasing barley straw fibres from 0 (sand plaster) to 75% increases the block resistance against water by a factor of about 21.5.

The mechanical behavior of plasters was studied by Ashour et al. (2010), where the influence of barley straw fibre on the compression strength of earth plaster was investigated. The reinforcement fibers have significant effect on the compression strength of the plasters. The compressive strengths for recipe A (75% fibre content) were 1.120, 1.406, 0.824 and 0.329 MPa for plaster reinforced with barley straw, wood shavings fibres, wheat straw and sand, respectively (Fig. 30). While the strengths of recipe B (50 % fibre content) were 1.001, 1.026, and 0.819 for barley, wood shavings and wheat straw respectively. The compressive strengths of recipe C (25% fibre content) were 0.917, 0.734 and 0.795 MPa for barley, wood shavings and wheat straw fibers, respectively.

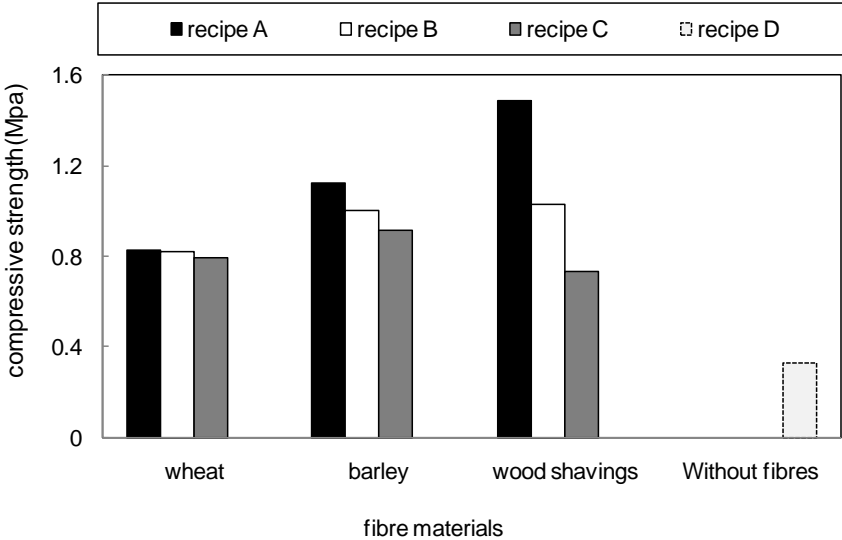

Figure 30. Compressive strength of earth plaster reinforced with different natural fibres

Ashour and Wu (2010) studied the effect of barley straw fibres on the shrinkage of earth plaster. The average shrinkage ratios of recipe A (75% fibre content) were 0.82%, 1.15% and 1.30% for curing temperature of 30°, 50° and 70°C respectively. For recipe B (50% fibre content), the shrinkage ratios were 0.86%, 1.30% and 1.55% for the temperatures of 30°, 50°

and 70°C respectively. The shrinkage ratios of recipe C (25% fibre content) were 0.95%, 1.67% and 2.30% for the curing temperature of 30°, 50° and 70°C respectively. The results are summarized in Fig.31.

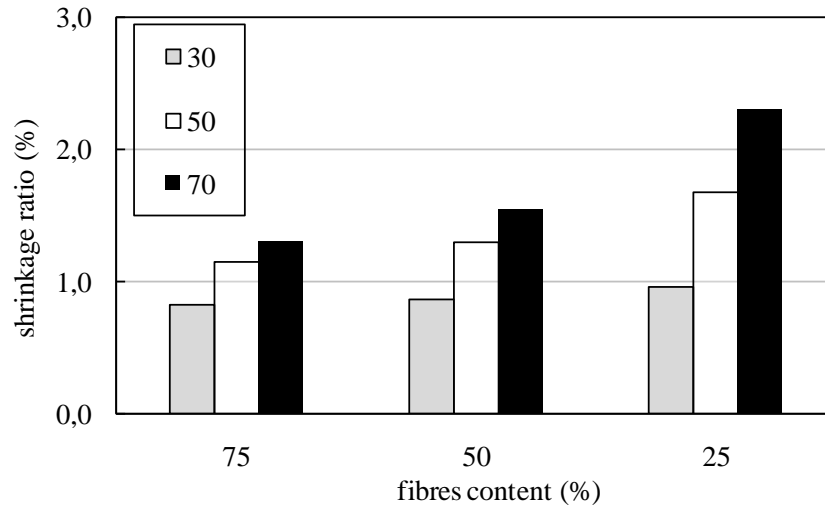

Figure 31. Shrinkage ratio of plaster reinforced with barley straw

The excellent properties of straw bales for acoustic insulation are shown by Deverell et al. (2009).

3. REFERENCES

- [1] Ashour T. and Wu W. 2010, An experimental study on shrinkage of earth plaster with natural fibres for straw bale buildings, *International Journal of Sustainable Engineering*, 3(4):299-304.
- [2] Ashour T. and Wu W. 2010, The influence of natural reinforcement fibers on erosion properties of earth plaster materials for straw bale buildings, *Journal of Building Appraisal*, 5: 329-340.
- [3] Ashour T., Bahanasawy A. and Wu W. 2010, Compressive strength of fibre reinforced earth plasters for straw bale buildings, *Australian Journal of Agricultural Engineering*, 1(3): 86-92.
- [4] Ashour, T. 2003, The use of renewable agricultural by-products as building materials. *PhD thesis*, Benha University, Egypt. (<http://www.downloads.fasba.de/TahaAshour-2003-complete.pdf>).

- [5] Ashour, T. and Wu, W. 2010, An experimental study on shrinkage of earth plaster with natural fibres for straw bale buildings, *International Journal of Sustainable Engineering*, 3(4): 299-304.
- [6] Ashour, T., Wieland, H., Georg, H., Bockisch, F.J. and Wu W. 2010, The influence of natural reinforcement fibres on insulation values of earth plaster for straw bale buildings, *Journal of Materials and Design* 3: 4676-4685.
- [7] Bainbridge, D.A. 1986, High performance low cost buildings of straw. *Journal of Agricultural, Ecosystems and Environment*, 16: 281-284.
- [8] Baklanova, N.I., Zima, T.M., Boronin, A.I., Kosheev, S.V., Titov, A.T., Isaeva, N.V., Graschenkov, D.V., Solntsev, S.S. 2006, Protective ceramic multilayer coatings for carbon fibers. *Surface and Coatings Technology*, 201: 2313-2319.
- [9] Billett M. 1979, *Thatching and Thatched Buildings*. Robert Hale, London, UK.
- [10] Brownie, P.M., Ponton, C.B., Marquis, P.M. and Butler, E.G. 1993, Zirconia sol coating of single-crystal ceramic fibres. *Journa of Material Design*, 14 (1): 49-51.
- [11] Chapman, L. 1996, Straw bale houses, building with a farming by-product *Canadian architect*, 41(5): 36-37.
- [12] Fernandez MA. 1993, *Report to the construction industries Division*, CID, state of New Mexico.
- [13] Fu, Y.C., Shi, N.L., Zhang, D.Z. and Yang, R. 2006, Effect of C coating on the interfacial microstructure and properties of SiC fiber-reinforced Ti matrix composites. *Materials Science and Engineering A*, 426: 278-282.
- [14] Ghailene B.A. 1993, Straw Bales and Straw Bale Wall Systems - Summary of a Structural Straw Bales Testing Programme, Online available: <http://www.buildinggreen>.
- [15] Goodhew, S., Deverell, R., Griffiths, R., De Wilde, P. 2010, The noise insulation properties of non-food-crop walling for schools and colleges: a case study. *Journal of Building Appraisal*, 5 (1): 29-40.
- [16] Hillman G. 1984, Interpretation of archaeological plant remains: the application of ethnographic models from Turkey. In: Zeist W van, Caspaeie W A (eds) *Plants and ancient man*. Balkema, Rotterdam, pp 1-41.
- [17] Hillman, G. 1981, Reconstructing crop husbandry practices from charred remains of crops. In: Mercer, R. ed. *Farming practice in British prehistory*. Edinburgh University Press, Edinburgh, pp 123-162.

- [18] Jones G. 1984, Interpretation of archaeological plant remains: ethnographic models from Greece. In: Zeist W, Casparie WA (eds) *Plants and ancient man*. Balkema, Rotterdam, pp 43-61.
- [19] Jones G. 1987, A statistical approach to the archaeological identification of crop processing. *J. Archaeol Sci* 14: 311-323.
- [20] King, B. P. E. 1996, Buildings of earth and straw. *Text book*. Ecological design press 1996, P. 95–152,(ISBN 0-9644718-1-7).
- [21] Lerner, K. and Donahue, K. 2003, Structural testing of plasters for straw bale construction. *Ecobuild Network*. Available from:www.ecobuildnetwork.org/pdfs/plaster_tests.pdf.
- [22] Lerner, K. and Goode, P.W. 2000, *The building official's guid to straw-bale construction*. A text book published the California straw building Association.
- [23] Magwood, C. and Mack, P. 2000, Straw bale building, how to plan, design and build with straw. *Text book*, New Society Publishers (ISBN 0-86571-403-7) P. 55-84.
- [24] McCabe, J. 1993, *The thermal resistivity of straw bales for construction*. Unpublished *Master's thesis*. Department Nuclear Engineering University of Arizona, Tucson, AZ.
- [25] Shi, Z.F. and Zhou, L.M. 2000, Interfacial deboning of coated fiber- reinforced composites under tension–tension cyclic load. *Acta Mechanica Sinica*, 16 (4): 347-356.
- [26] Spritzer 2010, Straw bale house project. Austria.
- [27] Steen, A., Bill S., and Bainbridge D. 1994. *The straw bale house*. Text book published byChelsea Green Publishing, White River Junction, Vermont, Totnes, England.
- [28] Stone L. 1999, A passive solar straw bale school. *Solar Today*, 13(1): 32-35.
- [29] Swearing, J. 2001, Moisture Barriers in straw-bale construction, www.skillful-means.com.
- [30] Thomason, J.L. and Dwight, D.W. 2000, XPS analysis of the coverage and composition of coatings on glass fibres. *Journal of Adhesion Science and Technology*, 14 (5): 745-764.
- [31] Watts, K.C., Wilkie, K.I., Tompson, K., and Corson, J, 1995, Thermal and mechanical properties of straw bales as they relate to a straw house. *Canadian Society of Agricultural Engineering*, Paper no. 1995-209.
- [32] Wimmer, R., Janisch, L. and Drack, M. 2001, Wandsysteme aus nachwachsenden Rohstoffen. *Ein Projekt Bericht im HAUS der Zukunft*. Im auftrag des Bundesministeriums fuer verkehr, Innovation und Technology.